

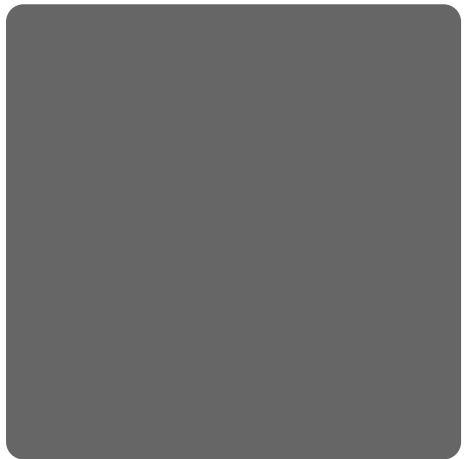

Designed for the real world

# Instructions



60cm slot-in  
double oven  
cookers

This book covers:

EW74

EW75

---

# Contents

---

	Page
Introduction	4
Installation	5
Safety Information	6-7
Features	8
The Controls	9-10
The Timer	11-16
Temperature Conversion Chart	17
Use and Care of the Ceramic Hob	18-20
Grilling	21-22
Top Oven – Conventional Cooking	23
Cooking Temperature Charts	24-25
Main Oven – Fan Cooking	26
Slow Cooking – Main Oven	27
Care and Cleaning	28-31
If something goes wrong / If it still won't work	32
Hotpoint Service Cover	34
Key Contacts	back page

## Retention of this Instruction Book

This Instruction Book must be kept handy for reference as it contains important details on the safe and proper use of the appliance.

If you sell or pass the appliance to someone else, or move house and leave it behind, make sure this Book is also provided so the new owner can become familiar with the appliance and safety warnings.

---

# Introduction

---

Your new appliance is guaranteed\* and will give lasting service. This guarantee is only applicable if the appliance has been installed in accordance with the installation instructions detailed in this booklet.

To help make best use of your cooking equipment, please read this booklet carefully.

The cooker is designed specifically for domestic use and responsibility will not be accepted for use in any other installation.

**When the cooker is first used an odour may be emitted,  
this will cease after a period of use**

When first using the cooker ensure that the room is well ventilated (e.g. open a window or use an extractor fan) and that persons who may be sensitive to the odour avoid any fumes.

It is suggested that any pets be removed from the room until the smell has ceased. This odour is due to temporary finish on oven liners and elements and also any moisture absorbed by the insulation.

**\* The guarantee is subject to the provisions that the appliance:**

- (a) Has been used solely in accordance with the Users Instruction Book.**
- (b) Has been properly connected to a suitable supply voltage as stated on the rating plate attached to this equipment.**
- (c) Has not been subjected to misuse or accident or been modified or repaired by any person other than the authorised employee or agent.**
- (d) Has been correctly installed.**

This appliance conforms to the following EEC Directives:

Electromagnetic Compatibility	Low Voltage Equipment
89/336/EEC	73/23/EEC
92/31/EEC	93/68/EEC
93/68/EEC	



---

# Installation

---

**WARNING – THIS APPLIANCE MUST BE EARTHED.**

## Mains Connection

Your cooker should have been checked to ensure that the voltage corresponds with your supply voltage, this is stated on the rating plate, which is situated on the outer rear panel. The model number and serial number are located on the front of the cooker, as shown on the Feature's page.

The cooker must be connected by a competent person such as one who is a, NICEIC registered contractor to a suitable double-pole control unit with a minimum rating of 32A and a minimum contact clearance of 3mm (applicable to newer properties, older properties where a 30A double pole control unit and a minimum contact clearance of 3mm is acceptable).

The double pole control unit should be fitted adjacent to the cooker, in accordance with IEE regulations. The control unit must be within 2 metres of but not directly above the appliance and should be easily accessible in the event of an emergency.

The power supply cable should conform to B.S.6004 with a conductor size of 6mm<sup>2</sup>, minimum.

Access to the mains terminals is gained by removing the rear access cover. The mains cable must pass through the cable clamp adjacent to the terminal block. Sufficient cable should be used to allow the cooker to be pulled out for servicing.

**Ensure that the mains cable is routed away from any brackets affixed to the rear panel and is not trapped to the rear wall when pushing the cooker into position between cabinets.**

## Levelling

Four feet are fitted which can be adjusted up or down to set the height (900mm - 930mm) and level the cooker.

The feet can be simply screwed in or out to lower or raise the cooker.

After the correct height is achieved, lock the feet into position by tightening the locking nut using an open ended spanner.

**CAUTION:** Some soft floor coverings may get damaged if the cooker is not moved carefully.

**NOTE:** Ensure oven shelves are level by using a spirit level on the rod shelves.

## Siting the Cooker

The cooker is designed to fit between kitchen cabinets spaced 600mm apart. The space either side need only be sufficient to allow withdrawal of the cooker for servicing and cleaning. It can be used with cabinets one side or both as well as in an angled corner setting. It can also be used freestanding.

Adjacent side walls which project above hob level, must not be nearer to the cooker than 150mm and should be protected by heat resistant material. Any overhanging surface or cooker hood should not be nearer than 650mm.

**Note: This appliance must NOT be fitted on a platform.**

## Moving the Cooker

Before moving your cooker, switch off at the cooker control unit, ensure that it is cool.

Open the grill door sufficiently to allow a comfortable grip on the underside front edge of the oven roof, avoiding any grill elements.

## Radio Interference

This appliance conforms to EN 55014 regarding suppression of radio and television interference.

**Note: Take care in moving the cooker as it is heavy. Take care to ensure that any floor covering is not damaged.**

---

# Safety Information

---

**When used properly your appliance is completely safe but as with any electrical product there are certain precautions that must be observed.  
PLEASE READ THE PRECAUTIONS BELOW BEFORE USING YOUR APPLIANCE.**

## Always

- Remove all packing from the appliance before switching on for the first time.
- Understand the controls prior to using the appliance.
- Keep children away from the appliance when cooking as the surfaces will get extremely hot during and after use.
- Turn controls **off** when not in use.
- Stand back when opening an oven door to allow any build up of steam or heat to disperse.
- Always use dry good quality oven gloves when removing items from the oven/grill.
- Always place pans centrally over the hotplate making sure handles are kept away from the edge of the hob and cannot become heated by other hotplates or pans.
- Always take care to avoid heat or steam burns when operating the controls.
- Always turn off the electricity supply at the wall switch and allow the appliance to cool before cleaning (or changing an oven lamp if fitted).
- Always make sure the shelves are in the correct position before switching on the oven or grill.
- Always keep the oven/grill door closed when the appliance is not in use.
- Always keep the appliance clean as a build up of grease or fat from cooking can cause a fire.
- Always follow the basic principles of food handling and hygiene to prevent the possibility of bacterial growth.
- Always keep ventilation slots clear of obstructions.
- Always refer servicing to a qualified appliance service engineer.
- Always take care when removing items from the grill compartment when the lower oven is in use as the contents will be hot.
- Always turn off the electricity supply to the appliance at the wall switch should any glass panel (if fitted) crack or shatter and then DO NOT USE THE APPLIANCE until repaired.
- During use, the oven becomes hot. Care should be taken to avoid touching heating elements inside the oven.

---

# Safety Information

---

## Never

- Never stare at Halogen heating units.
- Never leave children unsupervised where a cooking appliance is installed as all surfaces will be hot during and after its use.
- Never allow anyone to sit or stand on any part of the appliance.
- Never store items above the appliance that children may attempt to reach.
- Never leave anything on the hob surface when unattended and not in use.
- Never remove the oven shelves whilst the oven is hot.
- Never heat up unopened food containers as pressure can build up causing the container to burst.
- Never store chemicals/food stuffs or pressurised containers in or on the appliance, or in cabinets immediately above or next to the appliance.
- Never place flammable or plastic items on or near the hob.
- Never fill a deep fat frying pan more than 1/3 full of oil, or use a lid.  
**DO NOT LEAVE DEEP FAT FRYING PANS UNATTENDED WHILE COOKING.**
- Never use the appliance as a room heater.
- Never use the grill to warm plates.
- Never dry any items on either the hob or oven doors.
- Never install the appliance next to curtains or other soft furnishings.
- Never operate the grill with the grill door closed as this will cause the appliance to over heat.
- Never use 'steam cleaners'.

### **SAFETY ADVICE IN CASE OF A CHIP-PAN FIRE**

In the event of a chip pan fire or any other pan fire.

1. TURN OFF THE COOKER APPLIANCE AT THE WALL SWITCH.
2. COVER THE PAN WITH A FIRE BLANKET OR DAMP CLOTH, this will smother the flames and extinguish the fire.
3. LEAVE THE PAN TO COOL FOR AT LEAST 60 MINUTES BEFORE MOVING IT. Injuries are often caused by picking up a hot pan and rushing outside with it.

**NEVER USE A FIRE EXTINGUISHER TO PUT OUT A PAN FIRE** as the force of the extinguisher is likely to tip the pan over.  
**Never use water to extinguish oil or fat fires.**

# Features

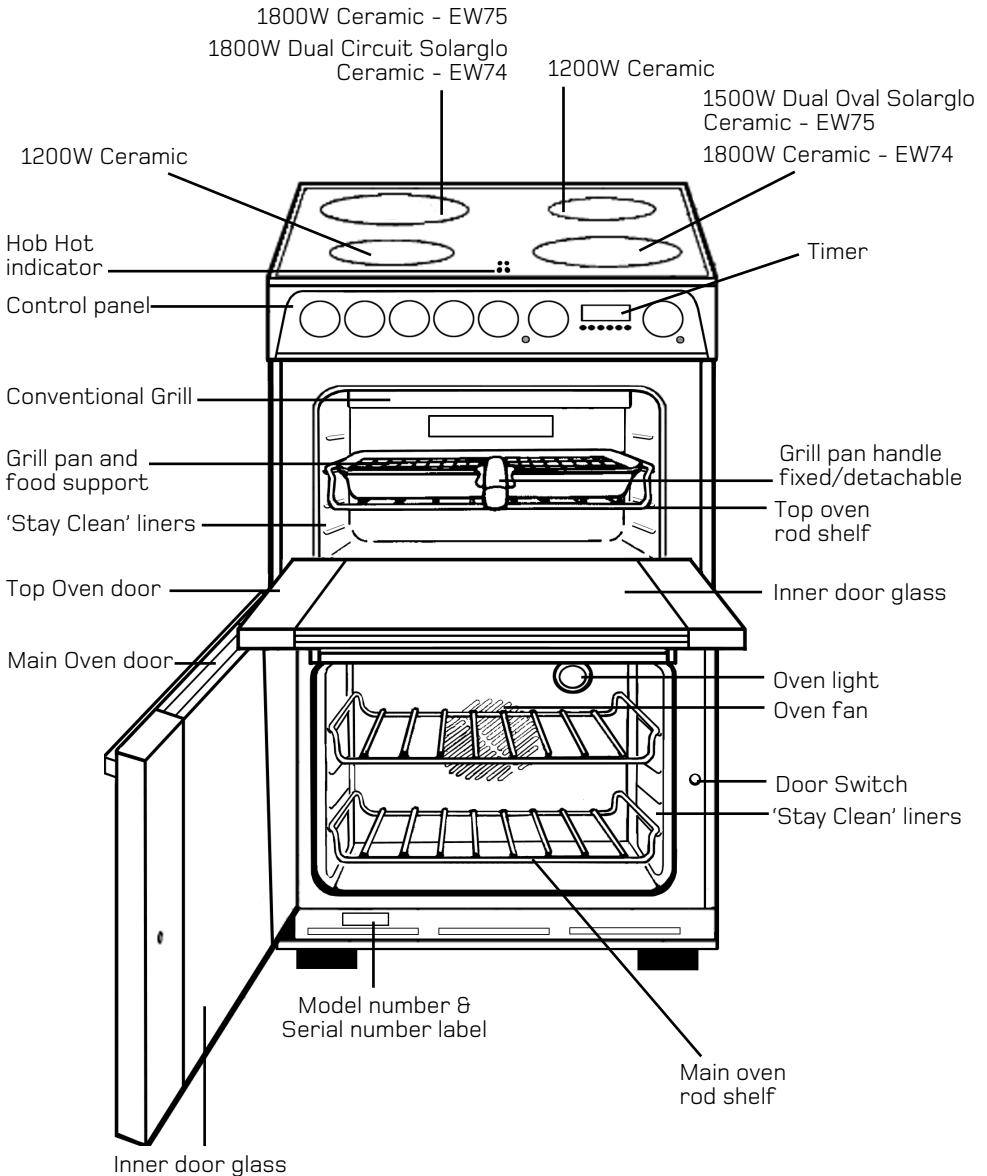



---

# The controls

---

Switch on the electricity supply to the cooker at the Cooker Control Unit.

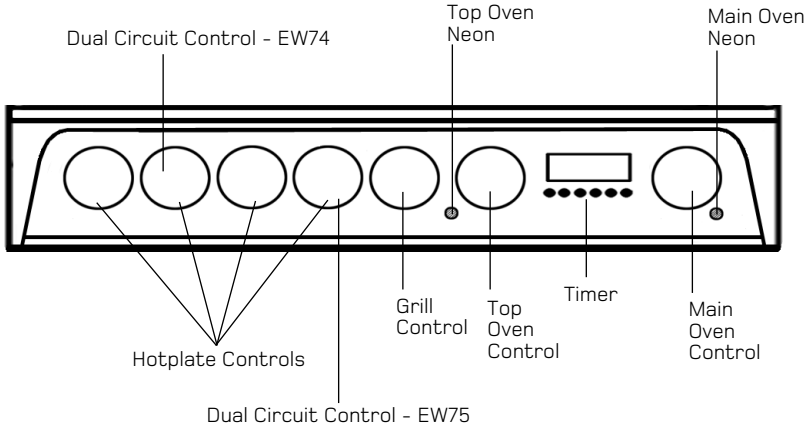

## Hob Controls

As each control knob is turned clockwise, numbers from 6 - 1 on the control knob decrease. Setting 6 is the highest/hottest. Setting 1 is the lowest/coolest. These are 6 fixed positions for cooking.

## Dual Circuit Control

This is to control a dual circuit plate with two elements. By turning the knob clockwise the whole hotplate is switched on, numbers 1-4 on the control knob, 4 is the highest setting. With the knob turned anti-clockwise, only the inner part of the hotplate is switched on, this is also indicated by numbers 1-4 on the control knob, 4 is the highest setting. Variable power for either the whole or the inner part of the hotplate is obtained by selecting any number between 1 and 4.

The off position is identified by an '0'.

The hob hot warning light will operate soon after any of the heating areas are switched on. It will remain illuminated until the ceramic surface has cooled down.

---

# The controls (continued)

---

## **Grill Control – Top Oven**

The grill control will not operate unless the top oven control is in the '0' off position.

The grill control provides fully variable heat control for either the twin grill or single (left hand side) grill by selecting any number between 1 and 4. When turned clockwise the twin grill will be switched on and any power setting from 1 - 4 can be selected. The power level numbers are indicated on the control knob.

When turned anti-clockwise the single grill will be switched on and any power setting from 1 - 4 can be selected. The power level numbers are indicated on the control knob.

The off position is identified by an '0'.

## **Top Oven Control**

This control switches on the top and bottom heating elements in the top oven. The temperature in the oven can be set anywhere between 100°C and 220°C. The red thermostat light will glow initially and remain on until the oven reaches the required temperature. It will then cycle off and on, as the oven thermostat maintains the correct temperature.

The off position is identified by an '0'.

## **Main Oven Control**

This control switches on the main oven. To select Fan Cooking – Turn the control clockwise and select any temperature between 80°C and 230°C. As the control is turned the fan will start, the oven interior light and the red main oven thermostat light will come on and the heating element around the fan will start heating.

The fan and the oven interior light will remain on throughout cooking.

The red main oven thermostat light will come on until the oven reaches the required temperature. It will then cycle off and on as the oven thermostat maintains the correct temperature.

## **Notes**

1. Never operate both the top oven control and the grill control together. The grill will not operate unless the top oven control is in the '0' off position.
2. If the main oven does not switch on when the control is turned, check that the Timer is in manual operation.

## **Slow Setting 'S'**

The main oven has an Economy setting to select. Turn the main oven control to the Slow Setting 'S' (see page 27).

NOTE: Slow Cooking can be cooked automatically (see Timer instructions).

---

# Oven Timer Operation

---

**Note: Timer must be set to 'Time of Day' and 'Manual' before the oven can be used.**

## AUTOMATIC COOKING

The Main Oven can be controlled by the Automatic Timer.

## HINTS ON AUTOMATIC COOKING

1. Select foods which will require the same cooking time and temperature.
2. To ensure food does not cool down and require reheating, set the end time so the food is ready when you require it.
3. Always ensure that meat and poultry is defrosted before placing in the oven.
4. Whenever possible, take food out of the refrigerator and keep it as cool as possible.
5. If cooking food that requires frying before placing in the oven for automatic cooking, keep the delay time to a minimum.
6. Never place hot or warm food in the oven for delay start cooking as it could cause the oven to be warm and produce harmful bacteria in the food.
7. We advise that dishes containing left-over cooked poultry or meat, e.g. Shepherd's Pie, should not be cooked automatically if there is to be a delay period.
8. Ensure that delay start times are kept to a minimum to prevent bacterial growth in food.
9. Wine or beer may ferment and cream may curdle during the delay period so it is best to add these ingredients just before serving.
10. Foods which discolour should be protected by coating in fat or tossing in water to which lemon juice has been added, prior to placing food in the oven.
11. Dishes containing liquid should not be filled too full to prevent boiling over.
12. Food should be well sealed (but not airtight) in a container to prevent the loss of liquid during cooking. Aluminium foil gives a good seal.
13. Always ensure that food is piping hot and cooked thoroughly before serving.
14. Only reheat food once.

# Know Your Timer

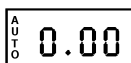

## CLOCKFACE

The timer incorporates a 24 hour clock.

**Ensure the correct time of day is always set, before using your cooker.**

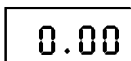

## SYMBOLS

A 'bell' symbol will light up when you select a Minute Minder Period and will remain lit for the period set.

At the end of the Minute Minder Period, the timer will emit an audible tone and the 'bell' symbol will disappear.

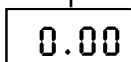

The 'cookpot' symbol will light up either:-

- When the timer is in manual mode, or
- During the actual Cook Period.

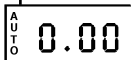

'AUTO' will light up:-

- When the timer is first turned on it will flash. It will go out when a time of day is set or when the timer is set to manual.

The 'AUTO' symbol will flash at the end of an Auto Cooking programme to indicate that the programme has finished.

***(When the 'AUTO' symbol is flashing, to return the oven to Manual operation, turn the oven controls off, ensure that the correct time of day is set, and press the "Manual" button - The 'AUTO' symbol will go out).***



## TIMER FUNCTION BUTTONS

### Minute Minder Button

Here you can set a time period of up to 23 hours 59 minutes, that will count down. When it reaches zero, the timer will emit an audible tone.

**For Example:** If you set 20 minutes, the audible tone will occur 20 minutes later.

## AUTO COOKING PROGRAMME

### Cook Period Button

Cook Period is the actual length of time for which, the timer will switch the oven(s) on as part of an "Auto Cooking" programme.

(e.g. If you set 2 hours, the food will be cooked for 2 hours).

### End Time Button

The time of day at which you want an "Auto Cooking" programme to **end**.

**For Example:** If you set a "Cook Period" for 2 hours, and "End Time" of 11:00. The timer will switch the oven(s) on at 9:00 and turn the oven(s) off at 11:00. You will hear a audible tone at 11:00, to indicate that the Auto Cooking Programme has finished.

#### Notes:

- When setting an Auto Cooking programme you will need to set the oven control(s) to the required temperature(s) when you set the timer.
- If an Auto Cooking programme has been set the oven(s) will only operate during the pre-programmed time.

### Manual Button

Needs to be pressed to cancel an Auto Cooking programme and return the oven(s) to Manual operation.

**"+" and "-" Buttons** Used to adjust the various timer function settings.

# Electronic Clock & Automatic Oven Timer Operation

## SETTING THE TIME OF DAY

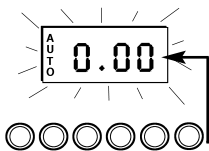

**Step 1** Make sure all oven controls are turned Off.

**Step 2** Check the electricity supply to the cooker is turned on.

**Step 3** When switched on the display will show 0.00 and the Auto symbol, flashing intermittently.

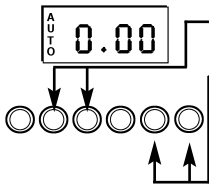

**Step 4** Press & hold in both the Cook Period & End Time buttons together.

**Step 5** With the Cook Period & End Time buttons still held in, press either the "+" or "-" buttons to set the correct time of day.

**Step 6** Release all the buttons simultaneously.

**THE TIME OF DAY IS NOW SET.**

*To change the time of day repeat Steps 4, 5 & 6 above.*

**Note:** You cannot adjust the time of day if the timer has been set for an Auto Cooking Programme.

## SETTING THE MINUTE MINDER

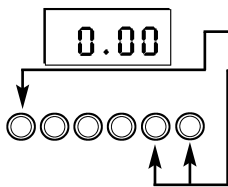

**Step 1** Ensure the time of day is set correctly.

**Step 2** Press and hold the Minute Minder button.

**Step 3** With the Minute Minder button held in, set the required Minute Minder period using the "+" and "-" buttons. A 'bell' symbol will light up.

Release all buttons and the timer display will revert back to the time of day. The 'bell' symbol will remain lit to signify that a Minute Minder period has been set.

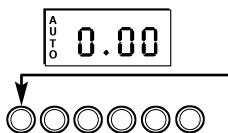

At the end of the set time an audible tone will be heard, and the 'bell' symbol will disappear.

**Step 4** To cancel the audible tone press the Minute Minder button.

**Note 1** When the Minute Minder has been set, the time remaining can be checked at any time by simply pressing the Minute Minder button.

**Note 2** If necessary the Minute Minder can be cancelled before the tone sounds by pressing and holding the Minute Minder button and then at the same time pressing the "-" button until 0.00 appears in the display window.

# Electronic Clock & Automatic Oven Timer Operation

## AUTO COOKING PROGRAMMES

There are two Auto Cooking programmes that can be selected using your timer:-

- (a) To set the timer to switch the oven On and Off Automatically
- (b) To set timer to switch on immediately and OFF automatically after a set cook period.

### a) TO SET THE TIMER TO SWITCH THE OVEN ON AND OFF AUTOMATICALLY

*This allows you to cook at a specified time for a chosen period before the oven switches off Automatically.*

**Step 1** Check that the correct time of day is set, if not follow instructions for setting the time of day.

**Step 2** Place food onto the correct shelf position in the oven and close the oven door.

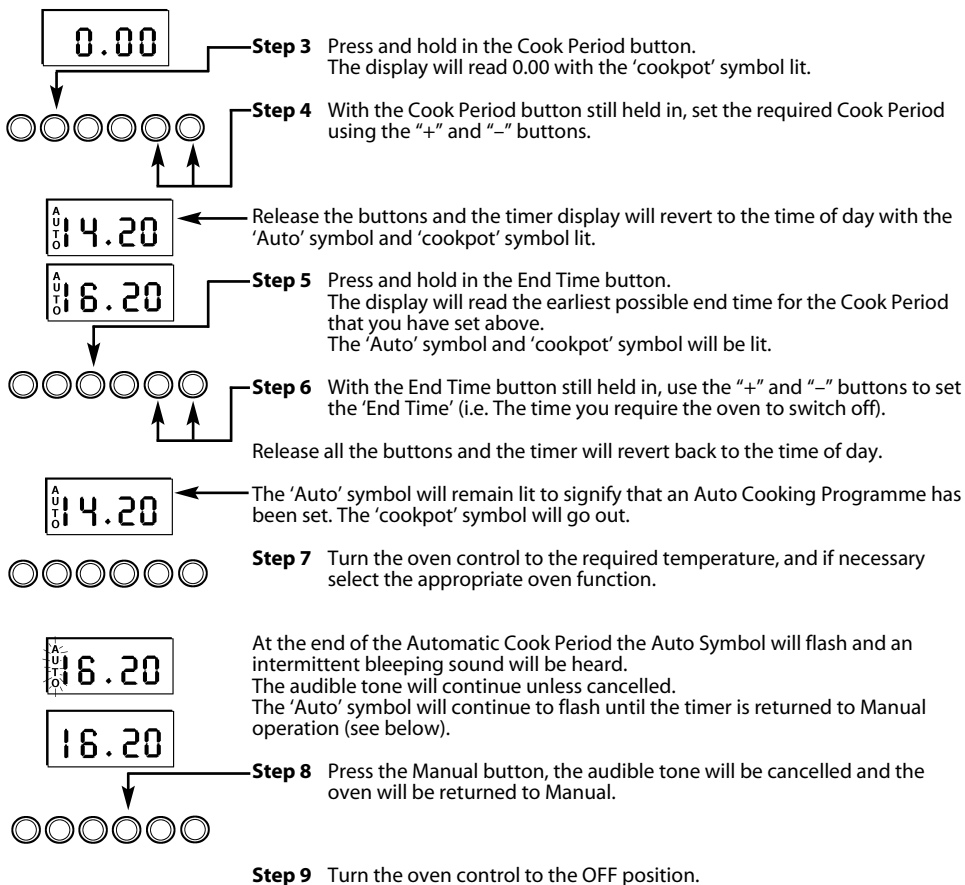

# Electronic Clock & Automatic Oven Timer Operation

**Note 1** When cooking automatically the Cook Period can be checked at any time by simply pressing the Cook Period button.

**Note 2** When cooking automatically the End Time can be checked at any time by simply pressing the End Time button.

## b) TO SET TIMER TO SWITCH ON IMMEDIATELY AND OFF AUTOMATICALLY AFTER A SET COOK PERIOD

- Step 1** Check that the correct time of day is set, if not follow instructions for setting the time of day.  
**Step 2** Place food onto the correct shelf position in the oven and close the oven door.  
**Step 3** Turn the oven control to the required temperature, and if necessary select the appropriate oven function.

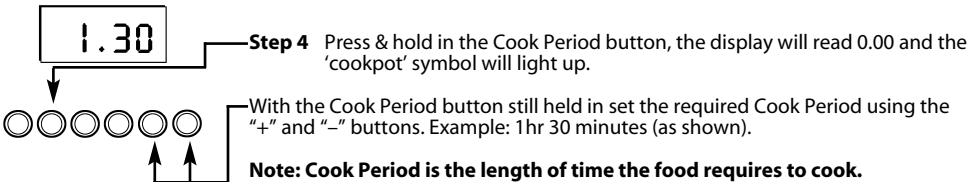

**Step 5** Release all buttons.

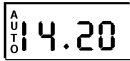

The timer display will revert to the time of day with the 'Auto' symbol lit & 'cookpot' symbol remaining lit.

NOTE: The Cookpot symbol disappears

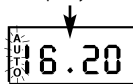

At the end of the Cook Period the 'Auto' symbol will flash and an intermittent audible tone will be heard. The audible tone will continue until cancelled. The 'Auto' symbol will continue to flash until the timer is returned to Manual operation (see below).

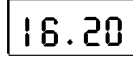

**Step 6** Press the Manual button. The audible tone will be cancelled and the oven will be returned to Manual.



**Step 7** Turn the oven control to the OFF position.

# Electronic Clock & Automatic Oven Timer Operation

## TO CANCEL AN AUTO COOKING PROGRAMME BEFORE THE COOK PERIOD HAS FINISHED.

**Step 1** Turn the oven control to the OFF position.

15.00

**Step 2** Press the Manual button to return the oven to "Manual" operation. The 'Auto' symbol will go out.



**Note 1** When cooking automatically the Cook Period can be checked at any time by simply pressing the Cook Period button.

### OTHER NOTES ON TIMER OPERATION

1. When cooking Automatically the Cook Period can be checked at any time simply by pressing the Cook Period button.
2. When cooking Automatically the End Time can be checked at any time by simply pressing the End Time button.
3. Having set a Cook Period and End Time an electronic device stores the information. The device within the timer will switch the oven on and off at the required times.
4. When setting an Auto Cooking Programme and a mistake is made, to clear:-
  - (a) Press and release the Manual button.
  - (b) Start the sequence again.
5. If at any time the display shows three flashing zero's 0.00 and 'Auto', it is likely that the electricity supply to the oven has been interrupted. Reset the timer to the correct time of day.  
**Food in the oven may, therefore, not have been cooked, before serving check food is thoroughly heated and completely cooked.**
6. To set each function always press and hold the required function button and at the same time press "+" or "-" buttons.



---

# Temperature Conversion Chart

---

Gas Mark	°F	Main Conventional Oven	Main Fan Oven
1/2	250	120	100
1	275	140	120
2	300	150	130
3	325	160	140
4	350	180	160
5	375	190	170
6	400	200	180
7	425	220	200
8	450	–	210
9	475	–	220

## Temperatures

The recommended temperatures given are for conventional and fan ovens. When using a fan oven it will be necessary to reduce the cooking time by 10 minutes per hour and lower the temperature by up to 20°C.

Also, in the majority of cases, it is not necessary to pre-heat the oven.

However, pre-heating is recommended when cooking items such as Yorkshire puddings, whisked sponges and bread. Your experience with the cooker will enable you to select the cooking time and temperature best suited for your recipe.

## Condensation

Condensation may become evident on the inner door and water may drip through the vent. This is normal when heat and moisture are present and may be a result of any of the following:

1. Kitchen temperature and ventilation.
2. The moisture content of the food  
eg. meat, roast potatoes, Yorkshire pudding, roasting meat, etc.
3. The quantity of the food being cooked at any one time.

# Using the Ceramic Hob

**WARNING: DO NOT USE THE HOB IF IT IS CRACKED. TO AVOID ELECTRIC SHOCK – SWITCH OFF AT THE COOKER MAINS CONTROL SWITCH IMMEDIATELY AND CONTACT YOUR NEAREST SERVICE OFFICE (see KEY CONTACTS, back page).**

## Ratings of Cooking Zones – EW74

Front Left	Front Right	Back Left	Back Right
Ceramic 1200W 160mm diameter	Ceramic 1800W 180mm diameter	Solarglo (dual circuit) 1800W 180mm diameter	Ceramic 1200W 160mm diameter

## Ratings of Cooking Zones – EW75

Front Left	Front Right	Back Left	Back Right
Ceramic 1200W 160mm diameter	Solarglo (dual oval) 1500W	Ceramic 1800W 180mm diameter	Ceramic 1200W 160mm diameter

### The Working of the Heating Zones

Heating only occurs within the marked circular cooking zones. The zones heat up and cool down quicker, providing greater controllability for sensitive foods. Each heating zone is equipped with a thermal limiter which is a safety cut-out which prevents the ceramic glass from overheating. After several minutes at full power without a pan on the heating zone the thermal limiter will switch the heating elements off and on automatically to avoid any damage to the ceramic glass.

### Choice of Saucepans

It is essential that the saucepans you use on the ceramic hob are suitable.

#### ALWAYS USE:

- Good quality pans with smooth, flat, heavy bases.
- Saucepans manufactured from aluminium (enamelled or machined) or stainless steel.
- Correct size saucepans. The base of the pan must cover the heating zone completely.
- Saucepans with lids which are well fitting to reduce cooking time and energy use.

#### NEVER USE:

- Pans with thin, distorted or uneven bases as these will extend cooking times, waste electricity and cause damaging, local hotspots on the glass surface.
- Pans with ridged or recessed bases.
- Pans with damaged or rough bases which could scratch the glass surface.
- Glass or glass ceramic utensils.

---

# Care of the Ceramic Hob

---

**In order to keep your ceramic hob in good condition, follow these simple guidelines:**

## Do Not

- Do not** stare at halogen heating units.
- Do not** cook directly on the hob surface without a cooking utensil, as this will result in damage to the surface of the hob.
- Do not** use the hob as a worktop surface as damage may occur to the smooth surface of the hob.
- Do not** drag or slide utensils on the hob surface, as this will cause scratches in the surface of the hob.
- Do not** allow a cooking utensil to come into contact with the hob surround.
- Do not** place anything between the base of the utensil and the ceramic hob, e.g. do not use asbestos mats, aluminium or wok stand. 
- Do not** leave any utensils, food or combustible items on the hob when it is not in use.
- Do not** place aluminium or plastic foil, or plastic containers on the hob.
- Do not** leave the hotplates or cooking areas switched **On** unless they are being used.
- Do not** leave heating zones uncovered when they are switched **On**.

We recommend not to place large preserving pans or fish kettles across two heating areas.

- Do not** leave utensils partly covering the heated areas. Always ensure that they are placed centrally over the heated areas and have the same diameter as the heating area used. 

## Do

- Always** ensure that the bottom of the pan is both clean and dry. Dirt, or moisture between the pan and the hob can cause pitting of the surface of the glass.

We do not recommend the use of utensils with a base diameter greater than 25cm (10ins).

Pressure cookers or other large pans should be used on the front cooking areas.

- Always** ensure that saucepan handles are positioned safely.
- Always** take extra care when cooking foods with a high sugar content eg. jam, as spillage will cause damage to the surface of the glass.
- Always** clean spills immediately (see Care and Cleaning).

---

## Care of the Ceramic Hob (continued)

---

**IMPORTANT** – As with any cooking appliance there could be some fire risk attached to the heating of oil, particularly for deep fat frying, cooking utensils containing oil **must not be left unattended** (e.g. to answer the telephone) on or in close proximity to the patterned cooking areas.

1. Use a deep pan, large enough to completely cover the appropriate heating area.
2. Never fill the pan more than one-third full with fat or oil.
3. Never leave oil or fat unattended during the heating or cooking period.
4. Do not try to fry too much food at a time, especially frozen food. This only lowers the temperature of the oil or fat too much, resulting in greasy food.
5. Always dry food thoroughly before frying, and lower it slowly into the hot oil or fat. Frozen foods, in particular, will cause frothing and spitting, if added too quickly.
6. Never heat fat, or fry, with a lid on the pan.
7. Keep the outside of the pan clean and free from streaks of oil or fat.
8. Never allow excessive splashing of oil onto the hob.

### Safety requirements for deep fat frying

In the unfortunate event of a chip pan fire:

1. Switch **Off** the electricity supply.  
**NEVER** attempt to move the pan - burns and injuries are caused almost invariably by picking up the burning pan and rushing outside with it.
2. Smother flames with a fire blanket or damp cloth.  
**NEVER** use a fire extinguisher to put out a pan fire, as the force of the extinguisher is likely to tip the pan over.  
**NEVER** use water to extinguish oil or fat fires.  
When smothering the flames **DO ENSURE** that you **FACE** and **ARMS** are **WELL PROTECTED** from the flames to save you from becoming hurt.
3. After the fire has been extinguished **LEAVE THE PAN TO COOL FOR AT LEAST 60 MINUTES BEFORE MOVING IT.**
4. If you fail to put the fire out, call the fire brigade immediately.

# Grilling

**CAUTION: Accessible parts may become hot when the grill is in use – children should be kept away.**

**Grilling must be done with the top oven door open. Control knobs may become hot during grilling. The operation of the controls is covered on page 9. Remember the grill will not operate until the top oven control is in the '0' off position.**

**To operate the grill proceed as follows:**

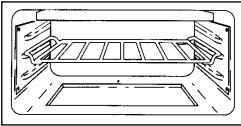

- Open the grill/top oven door.
- When toasting or grilling, the rod shelf can be placed on either of the runners.
- Preheat the grill on setting 4 for approximately 5 minutes, using either the single (left hand side) or twin width setting, depending on the amount of food to be cooked.
- Fixing the grill pan handle - Ensure that the handle is secure before use (see figs 1,2 and 3 on next page). The food to be cooked should be placed on the grill pan/grill pan grid. Place the grill pan on the shelf and push back until the pan is correctly positioned beneath the grill element.

## Notes

When positioning the grill pan, for grilling, ensure that the grill pan handles do not become 'caught' in the oven shelf.

Before use ensure the grill pan handle is positioned correctly.

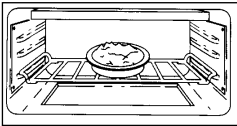

- Food which only requires browning should be placed directly on the shelf, on either of the runners.
- Leave the control at setting 4 for toast and for the sealing and fast cooking of foods. For thicker foods requiring longer cooking, turn the control to a lower setting after the initial sealing on both sides on setting 4. The thicker the food the lower the control should be set.

**WARNING: Take care as oven/grill will be hot – always wear oven gloves. ALWAYS ENSURE THE GRILL PAN IS CLEAN BEFORE USE – EXCESS FAT BUILD UP IN THE BOTTOM OF THE PAN COULD CAUSE A FIRE HAZARD.**

# Grilling (continued)

## GRILL CHART

- Pre-heat the grill for 5 minutes on maximum control setting before grilling

Food	Grill Setting	Approximate Cooking time
Toasting of Bread products	4	3 - 10 mins.
Small cuts of meat, sausages, bacon, etc.	4 for 4 mins. reduce to lower setting.	10 - 20 mins.
Chops etc. Gammon steaks Chicken pieces	4 for 6-8 mins. reduce to lower setting.	20 - 30 mins.
Fish: fingers Whole Fillets	4	10 - 20 mins. Whole fish and fillets placed in the base of the grill pan.
Fish in breadcrumbs	3	15 - 20 mins.
Pre - Cooked potato products	3	15 - 20 mins.
Pizzas	3	12 - 15 mins. in the base of the grill pan.
Browning of food	4	8 - 10 mins. Dish placed directly on the shelf.

The settings in the above guide have been developed to cook food successfully without excessive fat spitting and splashing.

### Fixing the Grill Pan handle

The grill pan handle is detachable from the pan, to facilitate cleaning and storage. Fix the grill pan handle securely in position before use.

The handle fits onto the grill pan edge with the small recess, Fig. 1. Tilt the handle over the recess and slide it towards the centre, Fig. 2.

Ensure the handle is fully located. Insert washer and fixing screw and tighten fully to ensure handle is secured, Fig. 3.

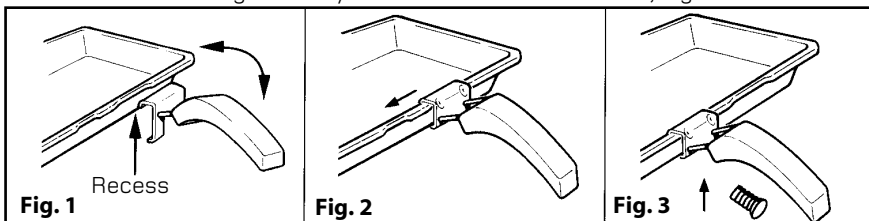

Always fit the screw prior to use.

# Top Oven – Conventional Cooking

The heat for conventional cooking in the top oven is provided by the grill element and the element under the floor of the oven. It is ideal for the slow cooking of cheaper cuts of meat in casseroles etc. but can also be used for small joints of meat up to 1.5kg (3lb).

The operation of the controls is covered on page 10. See cooking charts for temperatures and shelf positioning (pages 24 and 25).

The top oven can be used either independently to cook small quantities of food or in conjunction with the main oven to provide additional cooking space.

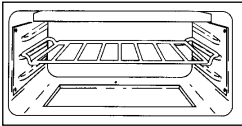

- The shelf should be positioned on the first or second runner from the bottom.

**To use the oven proceed as follows:**

25mm (1 in)

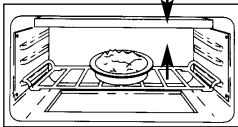

- Set the top oven control to the required temperature, the top oven light will come on and wait for the thermostat light to go off, indicating that the oven has reached the right temperature.
- The food to be cooked should be placed in the centre of the shelf with a gap of at least 25mm (1in) between it and the grill element. This should avoid burning and ensure even cooking.
- **Do not place food or dishes on the floor of the oven.**

## Platwarming in the top oven

Plates and dishes placed on the floor of the top oven will be heated when the main oven is in use.

When the main oven is not in use, for instance when a meal is being cooked on the hob, place the plates and serving dishes on the shelf using the bottom runner and turn the top oven control to approximately 100°C. A maximum time of 10-12 minutes is all that is required to heat the plates and dishes.

**NEVER** operate the grill control when using the top oven for cooking or warming plates and dishes.

**WARNING: DO NOT put delicate items china or items which could be affected by heat into the oven.**

# Oven Temperature Charts – Baking

Baking	Top Oven Cooking				Fan Oven Cooking		
	Pre-heat	Temperature °C	Time in mins.	Position in Oven	Pre-heat	Temperature °C	Time in mins.
Food							
Scones	Yes	210/220	10-15	Runner 2 from bottom of oven.	Yes	210/220	9-12
Small Cakes	Yes	180/190	20-25	Runner 2 from bottom of oven.		170/180	15-25
Victoria Sandwich	Yes	170/180	20-30	Runner 2 from bottom of oven.		160/170	20-25
Sponge Sandwich (fatless)	Yes	180/190	20-25	Runner 2 from bottom of oven.	Yes	170/190	15-20
Swiss Roll	Yes	200/210	10-15	Runner 2 from bottom of oven.	Yes	190/200	12-15
Semi-rich Fruit cakes	Yes	150/160	60-75 7 inch	Runner 1 or 2 from bottom of oven		140/150	60-75 7 inch
Rich Fruit Cakes	Yes	140/150	Time Dependent on size	Runner 1 or 2 from bottom of oven		130/140	Depending on size
Shortcrust Pastry	Yes	190/200	Time Dependent on recipe	Runner 1 from bottom of oven.		190/200	Dependent on use
Puff Pastry	Yes	200/210	Time Dependent on recipe	Runner 1 from bottom of oven.		190/200	Dependent on use
Yorkshire Pudding	Yes	190/200	30-40	Runner 2 from bottom of oven.	Yes	180/190	30-45
Individual Yorkshire Puddings	Yes	200/210	20-30	Runner 2 from bottom of oven.	Yes	190/200	20-25
Milk Pudding	Yes	140/150	90-120	Runner 1 from bottom of oven.		130/140	105-135
Baked Custard	Yes	150/160	40-50	Runner 1 from bottom of oven.		140/150	40-50
Bread	Yes	200/210	30-45	Runner 1 from bottom of oven.	Yes	200/210	45-50
Meringues	Yes	100	150-180	Runner 2 from bottom of oven.		80-90	180-240

Note: If soft margarine is used for cake making, temperatures recommended by the manufacturers should be followed. Temperatures recommended in this chart refer to cakes made with block margarine only.



# Oven Temperature Charts – Meat

Top Oven Cooking			Fan Oven Cooking					
Meat	Pre-heat	Temperature °C	Time (approx.)	Position in Oven	Meat	Pre-heat	Temperature °C	Time (approx.)
Beef/ Lamb (slow roasting)	Yes	170/180	35 mins per 450g (1lb) + 35 mins over.	Runner 1 From bottom of oven.	Beef	No	160/180	20-25 mins per 450g (1lb) + 20 mins extra
Beef/ Lamb (foil covered)	Yes	190/200	35-40 mins per 450g (1lb)		Lamb	No	160/180	20-30 mins per 450g (1lb) + 25 mins extra
Pork (slow roasting)	Yes	170/180	40 mins per 450g (1lb) + 40 mins over		Pork	No	160/180	25-30 mins per 450g (1lb) + 25 mins extra
Pork (foil covered)	Yes	190/200	40 mins per 450g (1lb)		Veal	No	160/170	25-30 mins per 450g (1lb) + 25 mins extra
Veal (slow roasting)	Yes	170/180	40-45 mins per 450g (1lb) + 40 mins over		Chicken/ Turkey up to 4kg (8lb)	No	160/180	18-20 mins per 450g (1lb) + 20 mins extra
Veal (foil covered)	Yes	190/200	40-45 mins per 450g (1lb)		Turkey 4 to 5.5kg (9 to 12lb)	No		13-15 mins per 450g (1lb) at 150/160°C allow 12 mins per 450g at 150°C
Poultry/Game (slow roasting)	Yes	170/180	25-30 mins per 450g (1lb) + 25 mins over		Casserole	No	140-150	1 1/2 - 2 Hrs
Poultry/Game (foil covered)	Yes	190/200	25-30 mins per 450g (1lb)					
Casserole	Yes	150	2-2 1/2 hrs					

**If using aluminium foil, never:** **1.** Allow foil to touch sides of oven. **2.** Cover oven interior with foil. **3.** Cover shelves with foil.

The most accurate method of testing the readiness of joints of meat or whole poultry is to insert a meat thermometer into the thickest part of a joint, or the thickest part of poultry thighs, during the cooking period. The meat thermometer will indicate when the required internal temp has been reached.

**Beef -** Rare: 60°C    **Lamb:** 80°C    **Poultry:** 90°C  
 Medium: 70°C    **Pork:** 90°C  
 Well Done: 75°C    **Veal:** 75°C

---

# Main Oven – Fan Cooking

---

The heat for fan cooking in the main oven is provided by an element situated at the back of the oven, around the fan

Fan cooking is ideal for large poultry or joints of meat, reducing cooking times and often eliminating the need for pre-heating the oven. It is also ideal for batch cooking where food is cooked on more than one level, because the forced circulation of hot air gives an even temperature from the top to the bottom of the oven.

The operation of the controls is covered on page 10.  
See cooking charts for temperatures and shelf positioning (pages 24 and 25).

**To use the oven  
proceed as follows:**

- The shelves should be evenly spaced. To avoid unnecessary cleaning, shelves which are not in use should be removed from the oven.
- Set the main oven control to the required temperature. Pre-heating is not normally necessary, but some foods such as bread, scones and Yorkshire pudding do benefit from being placed in a hot oven (see cooking charts).
- Place the food to be cooked in the centre of each shelf to allow for even air circulation around the food.

---

# Using The Slow Cook Setting 'S'

---

## 'S' SLOW setting

This is used for slow cooking, keeping food warm and warming plates for short periods. Extra care should be taken when warming bone china, as it may be damaged in a hot oven.

**DO NOT place food or plates directly on the oven floor as this could damage both the oven lining and the plates which are being warmed.**

### Advantages of "SLOW" cooking are:

- The oven stays cleaner because there is less splashing.
  - Timing of food is not as critical, so there is less fear of overcooking.
  - Inexpensive joints of meat are tenderised.
  - Fully loading the oven can be economical.
  - Cooking times can be extended in some cases by up to 2 hours.
- Bearing in mind these advantages, it makes sense to cook larger quantities of food than required and store them in a freezer to be used cold or for re-heating. It is important to follow the guidelines given for preparing food using the Slow Setting 'S'.

### Storage and re-heating of food:

1. If food is to be frozen or not used immediately, place it in a clean container and cool as soon as possible.
2. Always thaw frozen food completely in the refrigerator before re-heating.
3. Always reheat food thoroughly and ensure it is piping hot before serving.
4. Only re-heat food **once**.

### Operation:

1. Place the prepared food in the main oven and ensure the door is fully closed.
2. Select '**S**' (Slow Cooking Temperature) by turning Main Oven Temperature Control clockwise ensuring the oven door is fully closed.

### Points to consider when preparing food for "SLOW" cooking:

1. Make sure that the dishes to be used will fit into the oven ensuring enough room for air to circulate.
2. All dishes cooked on the slow setting will require a minimum of 6 hours, however, if they are cooked for 1-2 hours longer then deterioration in their appearance may be noticed.
3. Never cook joints of meat over 2.7kg (6 lb) or poultry over 2.0kg (4 lb 8oz). We do not recommend that joints of meat or poultry are stuffed before cooking on the slow setting.
4. To seal in the meat juices, always cook meat or poultry at 170°C for 30 minutes before wrapping in foil and placing on a rack over a meat tin (to allow good air circulation) before turning the control to the slow setting and cooking immediately.
5. Always ensure that joints of pork and poultry are thoroughly cooked by checking with a meat thermometer before serving.
6. Always thaw frozen foods completely before cooking. We do not recommend placing frozen food in the oven to cook.
7. Always bring soups, liquids and casseroles to the boil before placing in the oven.
8. Ensure that casserole dishes have a good seal (not airtight) and cover food first with foil and then the lid to prevent loss of moisture.
9. Ensure that fruit and vegetables are cut into even sized small pieces to cook properly.
10. Always adjust seasoning before serving.
11. If using dried red kidney beans it is important that the beans are soaked and then boiled for a minimum of 10 minutes before using in any dish to destroy any toxins.
12. Egg and fish dishes need only 1-5 hours cooking and should be included in day cooking sessions, where they can be checked from time to time.

---

# Care and Cleaning of the Oven

---

**WARNING: BEFORE CLEANING, SWITCH THE COOKER OFF AT THE MAINS COOKER CONTROL PANEL AND ALLOW IT TO COOL. IT IS ESSENTIAL THAT THE OVENS ARE CLEANED AND KEPT FREE FROM FATS, OIL AND GREASE.**

## Cleaning of the Ceramic Hob

- Always** clean spills immediately. If the hob is reused before cleaning, spillage will be baked on and be very difficult to remove.
- Always** switch the cooker **OFF** at the cooker control panel.

To minimise cleaning:

- Always** take care and avoid spills.
- Always** use a Ceramic Hob Cleaner-Conditioner whenever cleaning is done. The Cleaner-Conditioner forms a protective film on the hob and contains a mild detergent which makes cleaning easier. Hotpoint has a Cleaner-Conditioner which can be obtained, either through a local Hotpoint Service Centre or retailer, part no.6004.

To clean off stubborn stains, the following can be used when the surface has cooled:

1. Cif, non-scratch cream cleaner.
2. Heavy soil can be removed from the surface by **carefully** using a glass scraper.
3. Hard water stains, grease spots and any discolouration having a metallic sheen can be removed with Solvol Autosol Super or any **non abrasive** stainless steel cleaner.

After cleaning, always use the Cleaner-Conditioner and finish it off by polishing with a clean, dry paper towel.

- Never** use abrasive or chemical oven cleaners as they can damage the surface of the hob.

The visual effect of any scratches which may occur in use can be minimised by the use of Cleaner-Conditioner. Such scratches cannot be removed but do not affect the function of the hob in any way.

---

# Care and Cleaning of the Oven

---

**WARNING: BEFORE CLEANING, SWITCH THE COOKER OFF AT THE MAINS COOKER CONTROL PANEL AND ALLOW IT TO COOL. IT IS ESSENTIAL THAT THE OVENS ARE CLEANED AND KEPT FREE FROM FATS, OIL AND GREASE.**

- 'Stay Clean' Liners** 'Stay Clean' liners are covered with a special enamel which absorbs cooking soils. At higher temperatures the soiling is slowly destroyed. In most cases normal cooking at higher temperatures will permit this cleaning to take place automatically. However, if higher cooking temperatures are not used regularly then it may be necessary, in order to prevent heavy soiling, to run the oven at maximum temperature for at least two hours, from time to time. The 'Stay Clean' liners can be washed in warm soapy water followed by rinsing in clear water. Dry well with a soft cloth.  
**NOTE: Do not use enzyme washing powder, harsh abrasives or chemical oven cleaners of any kind.**
- Oven Fittings** The oven shelves can be cleaned either in a dishwasher or by using a fine steel wool soap pad. The grill and meat pans can be cleaned in warm soapy water using a fine steel wool soap pad to remove stubborn stains or in a dishwasher. They should be cleaned after each use.
- Oven Interiors** To clean the oven interiors remove all the oven fittings and where applicable the 'Stay Clean' liners. All types of oven cleaners can be used, but **do not** allow abrasive cleaners or oven spray to come into contact with the 'Stay Clean' liners. Use a fine steel wool soap pad to remove stubborn stains.
- Oven Door Cleaning** The inner door glass panel can be removed for easy cleaning, see page 30.
- Cooker Exterior** The outside of the cooker should be cleaned regularly to keep it looking like new. Wipe over with a soft cloth wrung out in warm water and dry with a soft clean cloth. You can use mild non abrasive cleaners but always read the manufacturer's instructions first. Always test their suitability on a small area of the cooker not noticeable in normal use.  
**NOTE: DO NOT use scouring pads or abrasive cleaners as they may scratch the surface.**  
Wear protective gloves when cleaning any part of your cooker.

---

# Care and Cleaning (cont.)

---

**Door and Control Panel (Glass)**

Regularly wipe with a clean, damp cloth and polish with a clean, dry cloth.

**Door and Control Panel Trims (Stainless Steel)**

Regularly wipe with a clean, damp cloth and polish with a clean, dry cloth.

**WARNING: TO AVOID ELECTRIC SHOCK, BEFORE REPLACING THE OVEN LIGHT, SWITCH THE COOKER OFF AT THE COOKER CONTROL UNIT (and allow to cool if the oven has been used).**

**Replacement of the Oven Light**

Unscrew the glass cover, using a suitable cloth to protect the fingers and remove carefully. Unscrew the existing light bulb, and remove. Screw the new bulb into position and replace the glass cover, with metal washer, until positioned securely.

---

# Care and Cleaning (cont.)

---

## CLEANING THE DOORS

Take particular care not to damage the inner surface of the door inner glass that is coated with a heat reflective layer. Do not use scouring pads, or abrasive powder, which will scratch the glass. Ensure that the glass panel is not subjected to any sharp mechanical blows.

Stubborn stains can be removed by using a fine steel wool soap pad. For slight soiling the inner glass panel may be cleaned, while still warm, without removing it from the door. After cleaning, rinse and dry with a soft cloth.

## SIDE OPENING DOORS

Cleaning the door glass is the same as the drop down doors, except take care to support the weight of the inner glass when removing and refitting.

## DROP DOWN DOORS

Remove the door inner glass as follows.

1. Open the door fully and remove the extrusion end caps (This should be done by hand but if it proves too difficult, simply lift the inner glass to ease the end caps out of position).

**NOTE: If you need to use a tool – be careful not to damage the extrusion or end cap.**

2. Carefully slide the inner glass towards you and withdraw it from its locating slots. Ensure that the door is not allowed to slam shut, due to the reduction in door weight. Clean the glass as described above.

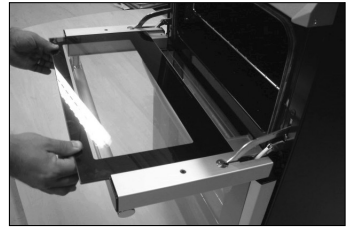

3. The inside of the outer door glass can now be cleaned while still fitted to the cooker.

**NEVER OPERATE THE COOKER WITHOUT THE INNER DOOR GLASS IN POSITION.**

Refit the door inner glass as follows.

1. Open the door fully.
2. Locate the inner door glass into its slots, so that the printing is readable from the face nearest the oven in the closed position and the widest black band is towards the bottom of the door. The inner door glass has a special reflective coating on one side, in order to minimise surface temperatures and energy consumption during use, it is important it is fitted correctly.
3. Carefully slide the glass into its slots as far as it will go and replace the end caps.

---

## If something goes wrong ...

---

### .... don't panic

Just quickly check these points before calling a Hotpoint engineer:

1. Check that the mains supply is switched on.
2. Check that the Automatic Cooking Symbol (Auto) on the Timer is not flashing, if it is set the oven back to Manual operation.
3. If using the Grill in the Top Oven make sure that the Top Oven Control is set to '0' Off.

## If it still won't work...

**Ring  
Service (see back cover)**



## Parts

Please remember your new appliance is a complex piece of equipment.

'DIY' repairs or unqualified and untrained service people may put you in danger, could damage the appliance and might mean you lose cover under Hotpoint's Parts Guarantee.

If you do experience a problem with the appliance don't take risks; call in Hotpoint's own Service Engineer (see KEY CONTACTS, back page).

Our spare parts are designed exclusively to fit only Hotpoint appliances. Do not use them for any other purpose as you may create a safety hazard.



---

# Notes

---

# Hotpoint Service Cover

## Satisfaction Guaranteed or Your Money Back

Hotpoint gives you a unique 'Satisfaction Guaranteed' promise – valid for ninety days after you have purchased your Hotpoint product. If there is a technical problem with your Hotpoint appliance, just call Hotpoint Service (see back page). If necessary we will arrange for an engineer to call. If the technical problem is not resolved under this Guarantee, Hotpoint will replace your appliance or, if you prefer, give you your money back. Your statutory rights are not affected, and the Guarantee is additional and subject to the terms of Hotpoint's Five Year Parts Guarantee.

## Hotpoint's Free Five Year Guarantee

From the moment your appliance is delivered Hotpoint guarantees it for **FIVE YEARS**.

- In the Five Years all replacement parts are **FREE** provided that they are fitted by our own Service Engineer. During the first year our Engineer's time and labour is also free.
- Our guarantee covers loss of food in our refrigeration and freezer products up to £250 during the first year, subject to verification by one of our engineers.
- After the first year we will charge for our Engineer's time and labour. We do, however, operate a range of Service Plans (see opposite) which, for an annual payment, enables you to cover any repair costs which may be necessary.
- All our service repairs are guaranteed for twelve months in respect of our labour and any parts fitted.
- The appliance must be used in the United Kingdom, and must not be tampered with or taken apart by anyone other than our own Service Engineers.
- You may, however, buy parts which can be safely fitted without specialist knowledge or equipment. The correct fitting of such parts, provided they are genuine Hotpoint spares, will not affect your Guarantee. Parts are available from our Hotpoint Spares Centres (see back page).
- Our guarantee does not cover the cost of any repair, or loss of food in refrigeration products, due to power failure, accidents or misuse. Nor does it cover the cost of any visits to advise you on the use of your appliance. Please read thoroughly the instruction book supplied with this appliance.
- If at any time during the Guarantee period we are unable to repair your appliance, we will refund any repair costs paid to us in the previous twelve months. We will also offer you a new appliance at a reduced charge instead of a repair.
- Our Guarantee is in addition to and does not affect your legal rights.
- Should you need independent advice on your consumer rights, help is available from your Consumer Advice Centre, Law Centre, Trading Standards Department and Citizens Advice Bureau.
- All Hotpoint servicing is carried out by our own Service Organisation located throughout the United Kingdom and Ireland. We will be happy to deal with any problems which you may have.

## Hotpoint's Extended Warranties

Whether you have just one or a number of Hotpoint appliances in your kitchen, Hotpoint has a range of Service Plans to give you complete peace of mind. They enable you to extend your one year labour guarantee so that you can have repairs completed **FREE** during the membership period.

## Service Cover

We offer a number of payment methods; cheque, credit card or you can spread the cost and pay by direct debit (full details can be obtained on Free phone 0800 716356). This covers you for all repairs during the period of cover, which can be from 1 to 4 years. Service Cover also includes loss of food, up to the value of £250, in refrigeration appliances. There is also an option of Service Cover with Maintenance at an additional cost. This includes an annual Electrical and Safety check and replacement of any parts as necessary.

## Kitchen Cover

An annual payment covers you for all repairs for all your Hotpoint appliances which are less than ten years old. It also covers the cost of loss of food up to £250 in our refrigeration and freezer products. There is also the option of Kitchen Cover with Maintenance at an additional cost. Any additional Hotpoint appliances purchased after you have joined Hotpoint Kitchen Cover will automatically be included during the annual period of cover without further charge.

## Appliance Registration

To ensure that you have the opportunity to benefit from any of the above Service Schemes and other offers you should complete and return immediately the Appliance Registration Form/Questionnaire supplied with this appliance. Full details and costs of our Service Schemes, together with an application form, will be sent to you at the end of the first year of the guarantee.

## Annual Safety/Maintenance Checks

Hotpoint strongly recommends that all its appliances are regularly checked for electrical and mechanical safety, whether or not they are covered by a Service Plan. Worn door gaskets or hoses may cause a leak on an appliance, which could become dangerous if neglected.

## Proof of Purchase

For future reference please attach your purchase receipt to this booklet and keep it in a safe place.

## Spares and Accessories

Spares and accessories can be ordered from your local Hotpoint Spares Centre (see back page), using the order form enclosed.

**NOTE:** Our Engineers will use every effort to avoid damage to floor coverings and adjacent units when carrying out repairs/service work, but in locations where the Engineer advises you that it will be impossible to move appliances without risk of damage, he will only proceed with your approval that no liability is accepted.

## Disposal of your product

To minimise the risk of injury to children please dispose of your product carefully and safely. Remove all doors and lids. Remove the mains cable (where fitted) by cutting off flush with the appliance and always ensure that no plug is left in a condition where it could be connected to the electricity supply.

To help the environment, Local Authority instructions should be followed for the disposal of your product.

## Disposal of old electrical appliances

The European Directive 2002/96/EC on Waste Electrical and Electronic Equipment (WEEE), requires that old household electrical appliances must not be disposed of in the normal unsorted municipal waste stream. Old appliances must be collected separately in order to optimise the recovery and recycling of the materials they contain and reduce the impact on human health and the environment.



The crossed out "wheeled bin" symbol on the product reminds you of your obligation, that when you dispose of the appliance it must be separately collected.

Consumers should contact their local authority or retailer for information

concerning the correct disposal of their old appliance.



# Key Contacts

## After Sales Service

Over 1100 trained specialists, directly employed by us, ensure that you can have complete confidence in both the appliances and services we offer.

## Repair Service and Information Help Desk

UK: 08709 066 066

Monday to Friday, 8am to 7.30pm

Saturday, 8.30am to 5.30pm

Sunday, 9.30am to 3.30pm

[www.hotpointservice.co.uk](http://www.hotpointservice.co.uk)

Republic of Ireland: 0818 313 413

Note: Our operators will require the following information:

Model number

Serial number

## Extended Warranties

UK: 08709 088 088

Monday to Sunday, 8am to 8pm

[www.hotpointservice.co.uk](http://www.hotpointservice.co.uk)

Republic of Ireland: 0123 002 333

## Genuine Parts and Accessories

UK: 08709 077 077

Monday to Friday, 8.30am to 5pm

Saturday, 8.30am to 12noon

[www.hotpointservice.co.uk](http://www.hotpointservice.co.uk)

Republic of Ireland: 0818 313 413

[www.hotpoint.co.uk](http://www.hotpoint.co.uk)

**Indesit** Company UK Limited, Morley Way, Peterborough, PE2 9JB